



BRAKE SYSTEMS



**INFORMATION ON  
BRAKE REPAIRS**



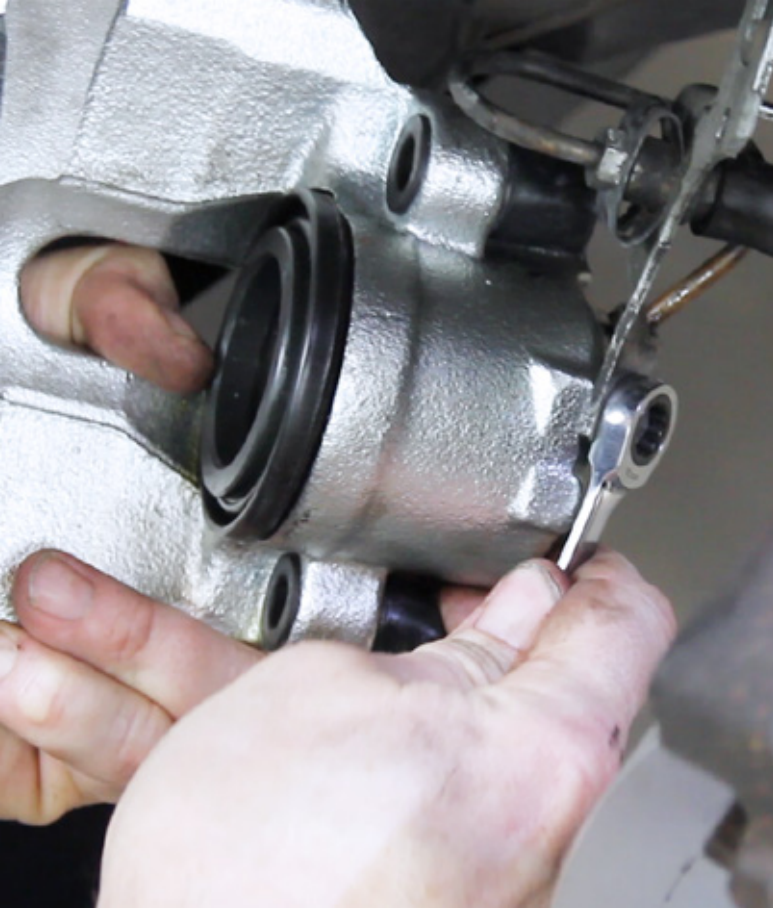

## Safety first!

1. The brake system is a safety system.  
Repair work on the brake system should only be carried out by trained specialists.
2. Use only spare parts that are 100% compatible with the brake system of the vehicle.
3. Use only approved brake pads and brake discs.
4. Observe the assembly manuals and the respective, vehicle-specific repair instructions.

# The basics of professional disc brake repair

## The following should always be observed!

1. Before installation, compare the new spare parts with the parts you have removed.
2. Brake discs should always be replaced in pairs and always together with new brake pads.
3. Before mounting a new brake disc, the wheel hub should be metallicly bright, flat, and free from burrs. It must then be preserved using a suitable spray oil.
4. A proper repair includes the replacement of all accessory parts, such as guide plates or screws. Please always use all parts provided.
5. Brake caliper shafts must be clean and rust-free, and the brake caliper guides must run smoothly.
6. Use only metal-free brake paste on the contact points between the brake pad and brake caliper. Avoid excessive greasing.
7. Components should be clean, should operate smoothly, and should be greased correctly in order to guarantee that the brake system functions properly and to prevent unnecessary noise.
8. In order to prevent damage to the wheel suspension or wheel hub, rough mechanical handling must be avoided when removing and installing brake components.
9. For correct assembly, always use brake-specific tools or, if necessary, special tools. Observe the prescribed tightening torques!
10. Since new brake discs and brake pads first need to adjust to one another, the brake system must be run in immediately following the repair. Comply with the vehicle manufacturers' run-in instructions!

# Brake pad structure

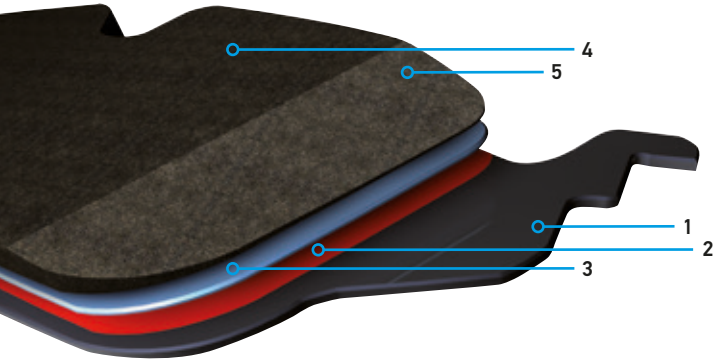

## 1. Steel pad base plate

The pad base plate is individually adapted to the requirements of the respective brake system with regard to the quality, strength, and tolerance.

Its task is to dissipate temperature and to guide the pad in the brake caliper. A powder coating enables the base plate to be given reliable corrosion protection.

## 2. Lining adhesive

Specially developed adhesives with a phenol resin base permanently join the brake pad to the base plate and ensure a high shearing strength.

## 3. Intermediate layer

The intermediate layer, also known as an underlayer, ensures the adhesion between the friction material and the adhesive. This improves the hardness, minimises the risk of cracking, and adds to the comfort features of the brake pad in general.

## 4. Friction material

The friction material has a very demanding job to do, and is therefore precisely tailored to meet the needs of the respective field of application.

### 5. Secondary measure

Various damping measures, or secondary measures, can be implemented on the brake pad in order to eliminate vibration noise. In addition to the familiar damping plates, a damping lacquer coating may also be used or a special modification may be made to the friction material.

### 6. Wear indicator

Wear indicators are monitoring devices for detecting when the brake pads need to be replaced. Mechanical displays are riveted onto the base plate. Electronic wear indicators are embedded in the friction material as an additional sensor.

### 7. Marking

For clear identification, the approved brake pads are marked with an imprint on the rear of the base plate. This ensures that it is always possible to determine where, when, and by whom the brake pad was manufactured.

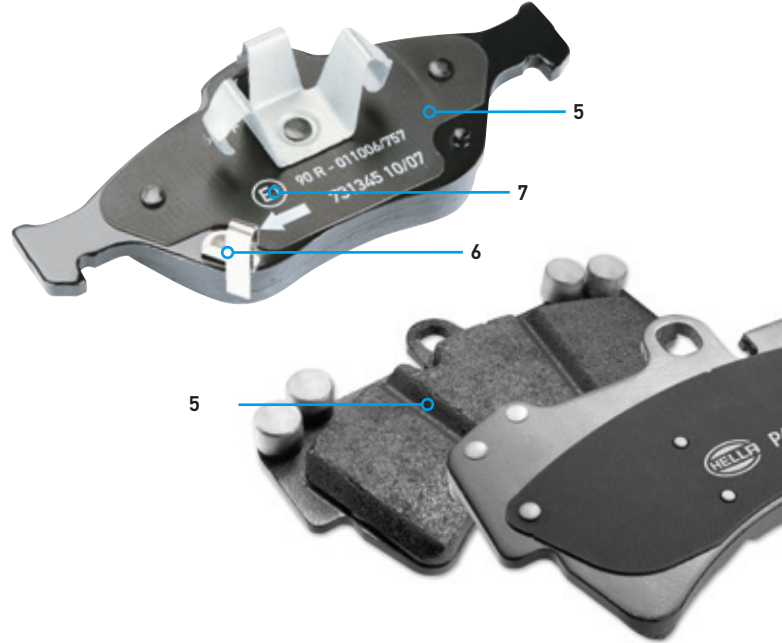

# Brake pad marking

1. ECE number
2. PA4029GF  
PA (manufacturer)  
4029 (material key)  
GF (US friction value code)
3. Hella Pagid part number
4. Hella Pagid batch number  
- defines the unique product composition
5. Environmental code
6. Part number/technical information number



# Secondary measures

Braking noise is caused by friction value fluctuations during braking. Secondary measures are intended to suppress high-frequency vibrations and therefore prevent noise. These measures can vary from vehicle to vehicle depending on the structure of the brake system. In some brake pads, several measures may be used simultaneously.

## **Additional noise-damping measures on the rear of the base plate.**

These include a lacquer coating, textile surface, adhesive film, or additional damping plate.

- These measures and features further improve the braking effect and driving comfort
- Adhesive film also secures the brake pad in its operating position and prevents misalignments and noise



## Chamfers

Chamfers are tapers in the friction surface individually developed for each brake pad. The final contour of the chamfer is determined through extensive driving tests as well as on test stands.

### Task

- To improve the transition between the brake pad and brake disc
  - Sharp edges are avoided
  
- To reduce vibrations and noise when initiating the braking process
  - By altering the contact surface on the brake disc, the pressure on the brake pad is increased even at low speeds





### Weights on the brake pad

An additional weight mounted on the brake pad increases the overall mass and thus reduces the resonant frequency of the component.

Depending on the design and positioning of the weight, the resulting vibration damping can reduce noise in a targeted manner or eliminate it altogether. The design of the weight may vary depending on the vehicle manufacturer and the brake system.



### Slots in the brake pad

Depending on the size and shape of the brake pad, cracks may form in the friction lining as a result of temperature-dependent expansion.

Slots are milled into some brake pads in order to prevent these cracks. These also reduce noise and hold brake pad wear particles.



## Directional brake pads

These brake pads are adapted to the installation position in the brake caliper and the running direction of the brake disc through special secondary measures such as chamfers or damping plates.

A crescent-shaped recess on the rear alters the press-on position of the piston-side brake pad. This reduces noise and improves the comfort characteristics. The running direction is indicated by an arrow. Special installation instructions are provided for the respective brake pads.

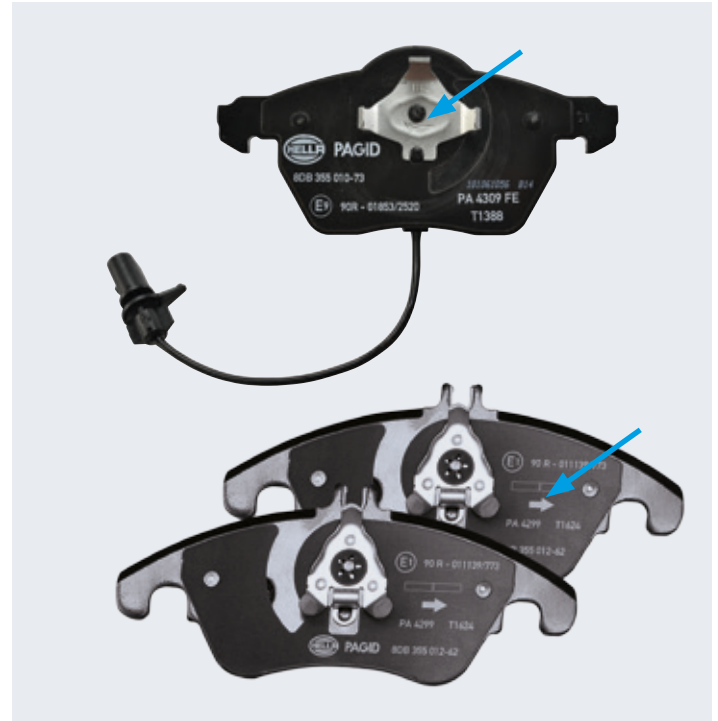

# Damage patterns of disc brake pads

## Separation of the brake pad

The brake pad is coming away from the base plate

### Cause:

- Thermal overload
- Underlying rust
- Base plate warped due to inaccurate fit or assembly fault



# Thermal overload

Brake pad damaged by overheating.

The binding agents in the pad are destroyed and the brake pad material cracks.

## Cause:

- Jammed or stuck brake pad
- Jammed or stuck guide sleeve
- Brake caliper piston is stiff
- Extreme driving patterns or continuous braking

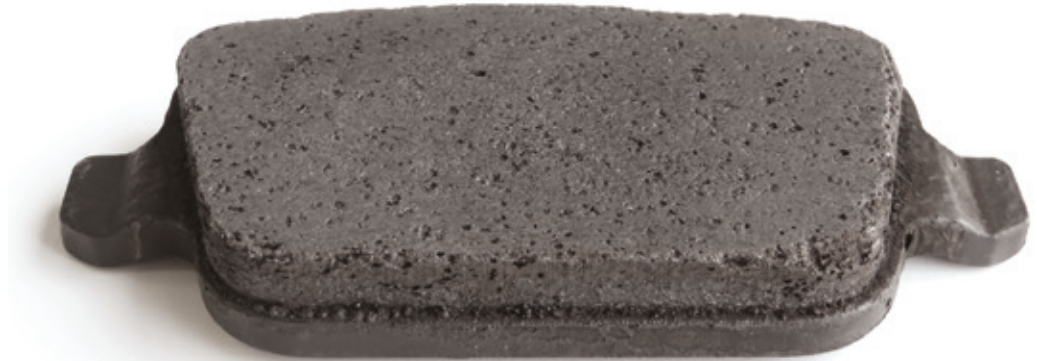

## Unauthorised mechanical processing

The brake pad has been mechanically altered. The subsequent processing of a brake pad, for example modifying the brake pad contour or the base plate, is not permitted. Unauthorised modifications to the brake pad result in altered braking characteristics and, in extreme cases, may lead to failure of the wheel brake.



## Worn patches and scoring

The surface of the brake pad exhibits marked scoring and worn edges.

### Cause:

- New pads were mounted on old, worn brake discs
- Foreign body between the brake pad and the disc
- Environmental influences (salt, dirt, etc.)



## Material or edge breaks

The brake pad has broken out at the edges.

### Cause:

- Thermal overload
- Faulty assembly



# Excessive wear

Brake pads are worn down to the base plate.

## Cause:

- Inadequate maintenance
- Inspected too infrequently
- Continuous braking on descents





## Faulty assembly

Assembly instructions not observed.

The adhesive film on the back was not removed prior to assembly.

Furthermore, the film has been needlessly greased with brake paste. This installation error leads to the brake pad being positioned incorrectly in the brake caliper, resulting in noise and premature wear.



# Damage patterns of brake discs

## Overheated brake disc

Judder marks.

### Cause:

- Thermal overload in the break-in phase
- Violent or sudden braking

### Effects:

- Noise and vibrations when braking from high speeds

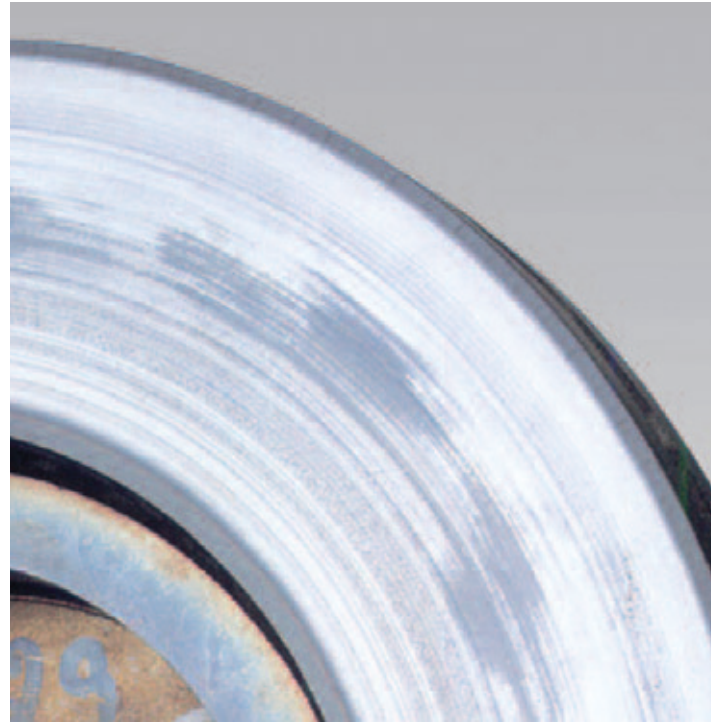

## Brake disc discoloured from standing

### Cause:

- Brakes used too infrequently
- Leaving the vehicle parked for long periods and environmental influences cause corrosion and surface changes of the friction ring

### Effects:

- Braking noises
- Signs of juddering



# Non-uniform thickness of friction ring

## Cause:

- Faulty or unclean assembly of the brake disc on the wheel hub
- Contact surface on the wheel hub not properly cleaned

## Effects:

- Wobbly movement of the brake disc
- Disc runout when braking only slightly
- Juddering when cold

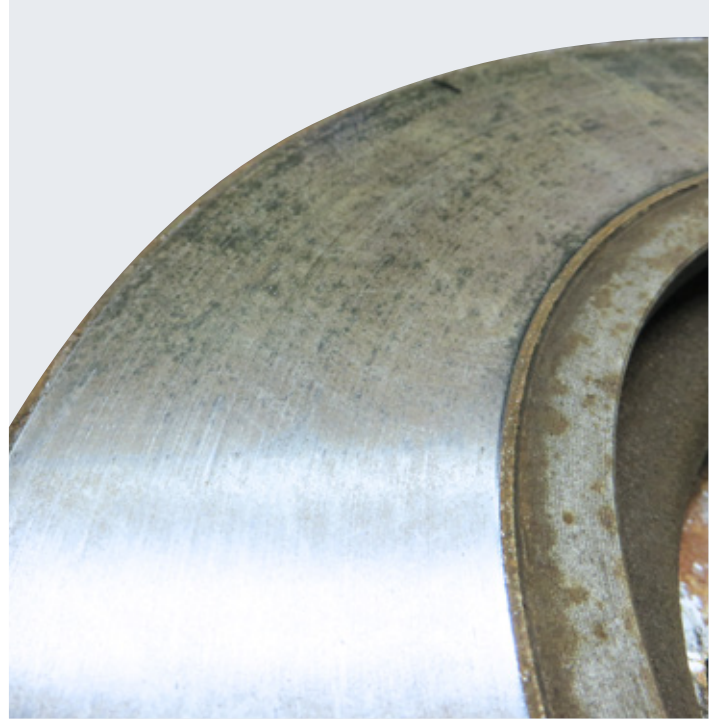

## Brake disc with scoring

### Cause:

- Overloading
- Effects of dirt
- Poor-quality brake pad

### Effects:

- Reduced braking effect
- Noise
- Increased wear



## Brake disc with severe heat cracks

### Cause:

- Mechanical alternating loads
- Thermal overload

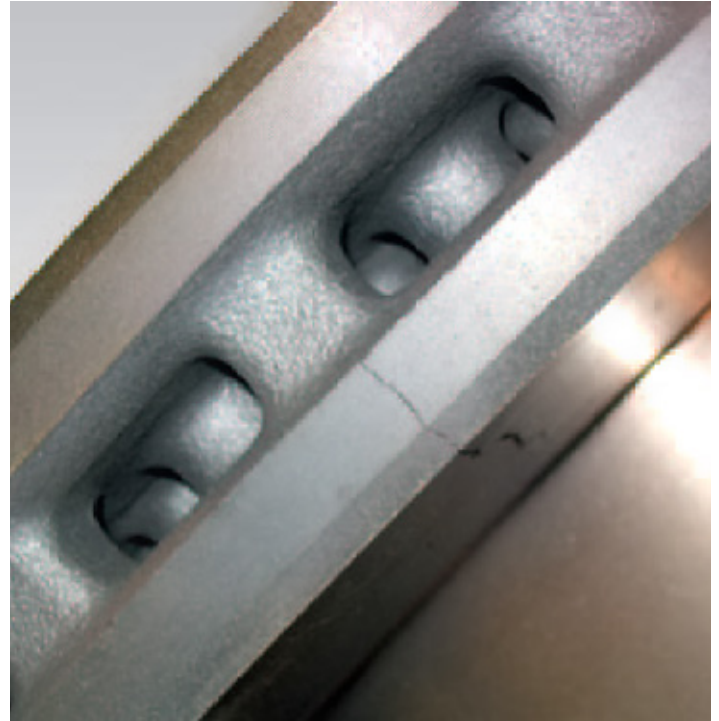

## Rust underneath the contact face of the brake disc chamber

### Cause:

- Faulty assembly
- Wheel hub not properly cleaned

### Effects:

- Non-uniform thickness
- Lateral runout



## Cracks near the disc chamber

### Cause:

- Wrong torque
- Faulty assembly

### Effects:

- Reduced stability
- Noise
- Steering wheel flutter

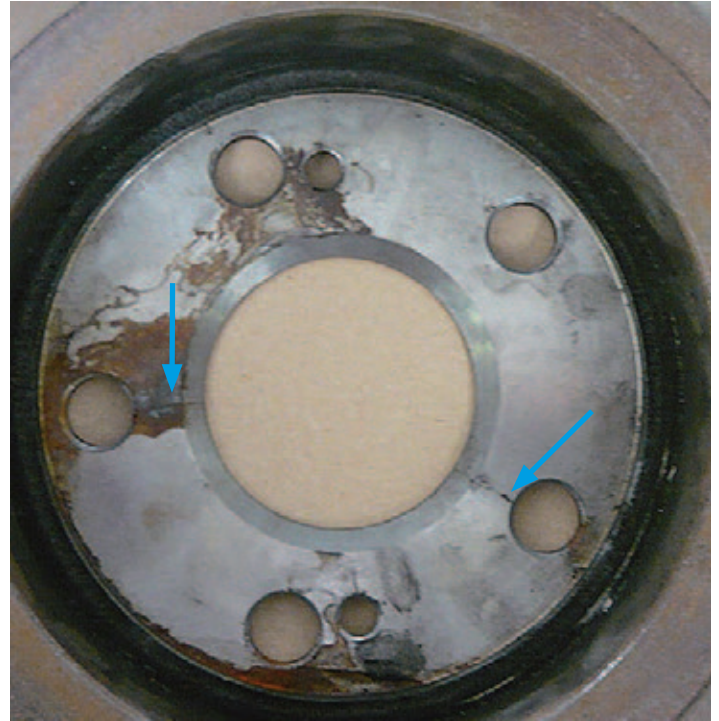



# Professional inspection of the brake system

## Brake fluid

Check the brake fluid level at the expansion tank.

→ The display should be between MIN and MAX.

A low fluid level may indicate a brake system leak or worn brake pads.

Only use new brake fluid that has been approved for the vehicle type!

→ Check: Wet boiling point, water content critical (>3%)

### Change intervals:

Every 24 months. Observe the vehicle manufacturer's maintenance specifications



# Brake pad

Before installing new brake pads, a visual check of the removed brake pads should first be carried out.

Check the brake pad for exterior damage:

- Check the surface structure of the friction lining for cracks or joints
- Check the pad base plate for deformation or jamming

**Check the contact patterns of the friction surfaces for wear:**

- The wear pattern may indicate further possible faults in the brake system

**Wear limit:**

- Brake pad (friction lining): At least 2-3 mm  
Always observe the wear limit of both brake pads on one wheel side!  
Observe the vehicle manufacturer's wear specifications!

**Brake pad wear indicator**

- Check the wear indicator and wiring for correct position and function
- Check the wiring and connectors for damage and correct position
- The wear indicator must be replaced with new brake pads!



## Brake disc

- Check the friction surfaces for scoring, wear, and corrosion.
- Check the minimum strength, thickness difference, and lateral runout of the brake disc.
- Minimum thickness: The MIN TH- value (mm) is stamped onto the disc.
- Disc runout: Max. 0.07 mm.
- Friction ring thickness difference: Max. 0.012 mm.

You must always observe the model-specific technical specifications of the vehicle manufacturer!

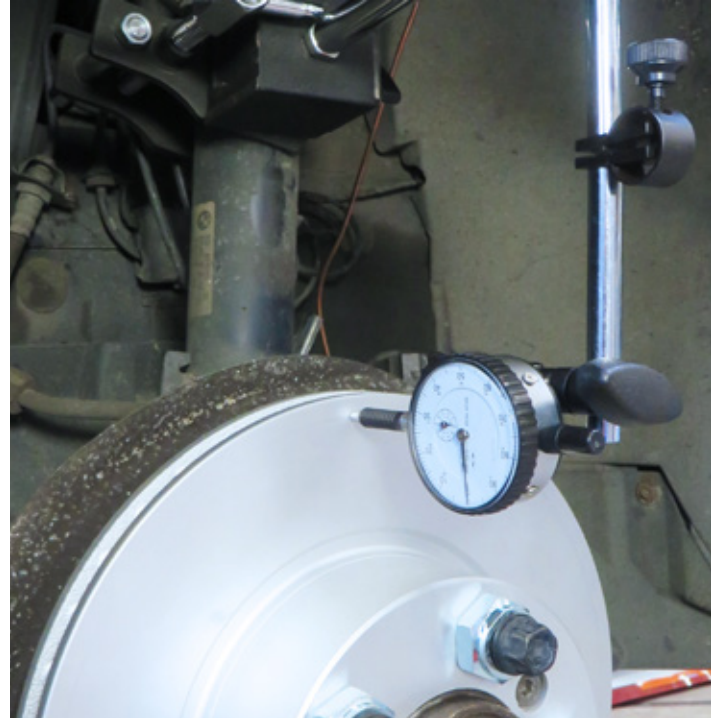

## Wheel hub

- Check the surfaces for damage and corrosion.
- Check the concentricity of the wheel hub.
- Check the lateral runout of the wheel hub: Max. hub runout: 0.03 mm.

The contact faces must be clean, rust-free, and metallically bright!  
Do not grease the contact faces! A faulty wheel bearing or impermissible wheel bearing play can lead to uncomfortable braking characteristics of the vehicle.



# Brake caliper

**Check that the mechanical components of the brake caliper are functioning properly:**

- Check the brake pad guides and caliper guides for contamination, damage, and corrosion.

**Check that the hydraulic components of the brake caliper are functioning properly:**

- Check that the pistons move easily: Jammed pistons result in faulty play and thus to overheating of the brake pads.
- Check the dust protection boot of the brake piston for damage: Faulty collars lead to corrosion of the piston and the bore hole.

**Check the guide bolts for ease of movement; check the protective plug and damping sleeves for damage:**

- Faulty components result in unwanted noise, incorrect wheel brake function, and premature or uneven brake pad wear.

During a repair, it is recommended to also replace the brake pad accessory kit!



## Wheel suspension and wheels

During the brake repair, it is recommended to also check the components in the area of the wheel brake, such as the wheels, threads, wheel bolts, steering, and axle suspension.

**Components that are damaged or not functioning properly have an effect on the braking characteristics.**

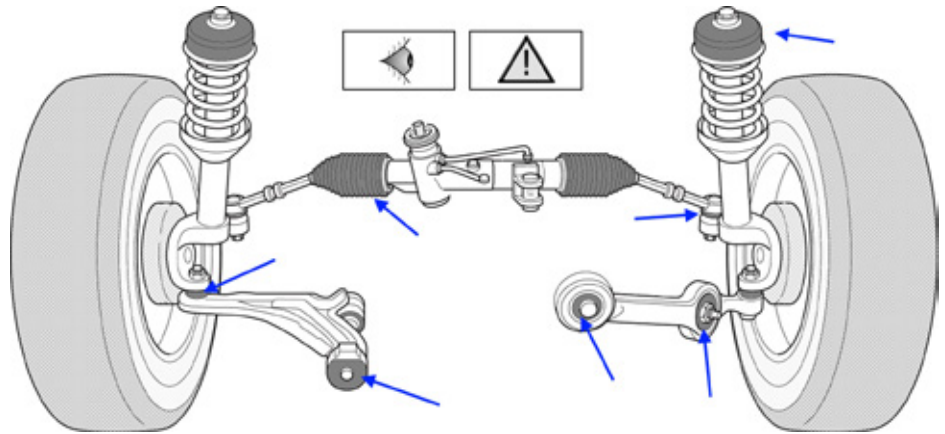

## Inspection on brake test stand

Check of the braking effect and permitted differences of an axle (automobile) in accordance with the EC directive.

- Braking force of service brake  
Front axle: Max. difference 25%
- Braking force of service brake  
Rear axle: Max. difference 25%
- Braking force of parking brake  
Manual operation: Max. difference 50%

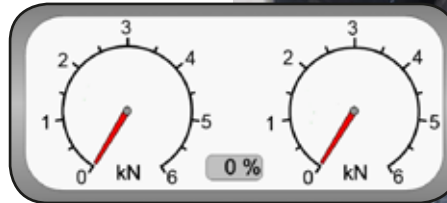

**The applicable national regulations must be observed!**

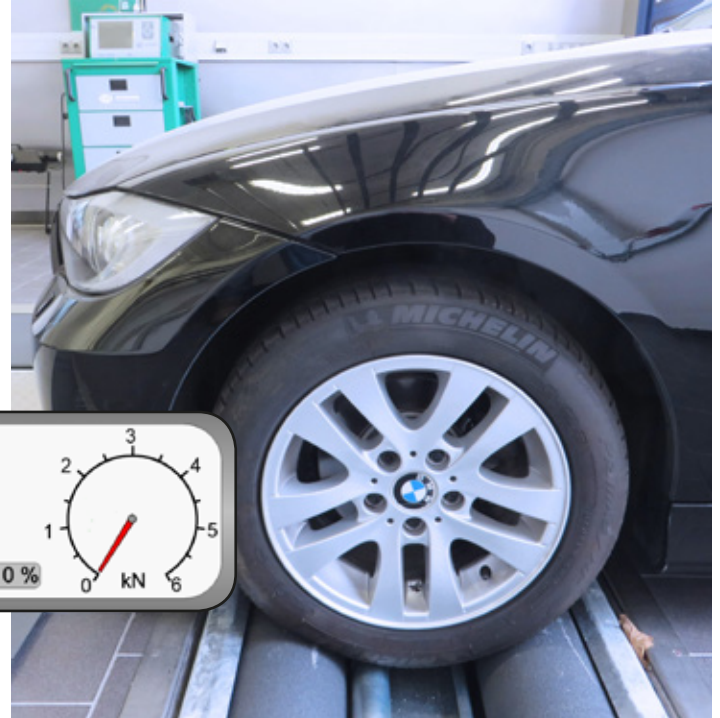

# Assembly instructions

The assembly instructions and notes included in the packaging must always be followed!

These contain special instructions, for example:

- Safety instructions for repair work on an electro-hydraulic brake system.
- Directional disc brake pads.
- Disc brake pads with removable film on the backplate.

Observing the installation instructions helps to prevent assembly faults and complaints!

1



2



FR



## Instructions de montage - Système de freinage SBC

Le système de freinage électro-hydraulique doit être désactivé avant chaque réparation.

- 1 Utilisez un appareil de diagnostic approprié pour la désactivation (par exemple un appareil de diagnostic Hella Gutmann Mega Macs 42SE, 56 ou 66).
  - 2 Seul un personnel spécialisé et qualifié est autorisé à intervenir sur les systèmes de freinage Sensoric Brake Control (SBC).
- Pour toutes les réparations, veillez à respecter les précautions de sécurité et instructions de montage indiquées pour le système ou par le fabricant. Les réparations inappropriées peuvent causer des dommages matériels et corporels.

SV



## Monteringsanvisning SBC - bromssystem

Det elektrohydrauliska bromssystemet måste alltid deaktiveras innan reparationer.

- 1 Använd lämplig diagnosutrustning för deaktiveringen (t.ex. Hella Gutmann Mega Macs diagnosutrustning 42SE, 56 eller 66).
  - 2 Endast kvalificerad specialpersonal får utföra reparationsarbeten på Sensoric Brake Control bromssystem (SBC).
- Följ alltid säkerhetsinformation och monteringsanvisningar från respektive system- eller fordonstillverkare vid alla reparationer. Felaktigt genomförda reparationer kan leda till att systemet slutar fungera och betydande personskador.

NL



## Montage-instructie SBC-remsysteem

Dit elektrohydraulische remsysteem moet voor iedere reparatie worden gedeactiveerd.

- 1 Gebruik voor het deactiveren een geschikt diagnoseapparaat (bijv. een Hella Gutmann Mega Macs diagnoseapparaat 42SE, 56 of 66).
- 2 Reparatiewerkzaamheden aan Sensoric Brake Control remsystemen (SBC) mogen uitsluitend worden uitgevoerd door gekwalificeerde vakmensen.

Neem bij reparaties altijd de veiligheidsvoorschriften en montage-instructies van de betreffende systeem- of voertuigfabrikant in acht. Verkeerd uitgevoerde reparaties kunnen systeemuitval en ernstig persoonlijk letsel tot gevolg hebben.



# HELLA PAGID fluids – A great product range

**OPTIMUM BRAKING PERFORMANCE. MAXIMUM SAFETY.  
EASY CARE AND MAINTENANCE.**

The comprehensive range of brake fluids from HELLA PAGID offers brake fluids that can be used individually for all conventional brake systems: DOT 3, DOT 4, DOT 4 LV, DOT 5.1, LHM. HELLA PAGID brake fluids are available in a range of container sizes.

The brake fluid product range from HELLA PAGID is appropriately supplemented with brake cleaner and mounting paste.

The brake cleaner from HELLA PAGID attracts brake dust and is a reliable means of removing oil, grease, dirt, and brake fluid – and it leaves no residue. In order to ensure safe functioning in the long term, the wheel brake must undergo regular maintenance. During maintenance, all mechanical parts should be greased with a temperature-resistant, non-metallic, permanent lubricant.



**HELLA Automotive South Africa (Pty) Ltd**

P O Box 603

Uitenhage

SOUTH AFRICA

6230

Tel.: +27 (0) 41-996-5700

Fax.: +27 (0) 41-996-5720

<http://www.hella.co.za>

© Hella Pagid GMBH, Essen

922 999 139-593 J01314/G+R/05.17/0.35

Printed in Germany

The reprinting, distribution, reproduction, exploitation in any form and disclosure of the contents of this document, even in part, is prohibited without our express written approval and indication of the source. The case examples illustrated in this document are for demonstration purposes only and do not claim to be complete.